



SRP-73

- process meter in a small case
- 2 display types: 4 x 13 mm or 5 x 9 mm
- inputs: 0/4-20 mA, 0/1-5V, 0/2-10V, 0-60/75/100/150 mV
- 0, 1 or 2 relay (or OC) outputs
- power supply output: 24V DC
- RS-485 / Modbus RTU
- free configuration software S-Config

The **SRP-73** meter is designed for measuring of typical current or voltage signals. Easy programming and installation, small size and high reliability are basic advantages of the **SRP-73** process meters. Thanks to wide range of characteristic curves (linear, square root, quadratic, user-defined and volume characteristic for cylindrical tanks) the meters may be used in various process control systems. The 24V DC / 100 mA output is designed to supply measuring transducers, and the RS-485 port enables data transmission in production process monitoring systems. The REL / OC control outputs can adjust the level of measured signal and are controlled according to one or two threshold values. The meter can be configured with the local keyboard or free S-Config software via the RS-485 communication port.

TECHNICAL DATA

Power supply	19V ÷ 50V DC; 16V ÷ 35V AC or 85 ÷ 260V AC/DC, all separated
Power consumption	for 85 ÷ 260V AC/DC and 16V ÷ 35V AC power supply: max. 4,5 VA; for 19V ÷ 50V DC power supply: max. 4,5 W
Display	standard: LED, two-coloured (red-green), 4 x 13 mm (IP 40); option: LED, red, 5 x 9 mm (IP 67)
Displayed values	-999 ÷ 9999 + decimal point
Input	current: 0-20 mA or 4-20 mA, programmable, input resistance < 65 Ω (typ. 55 Ω), overload-protected, input current limited to 40 mA voltage: 0-5 V, 1-5V, 0-10V or 2-10V, programmable, input resistance > 50 kΩ millivoltage: 0-60 mV, 0-75 mV, 0-100 mV, 0-150 mV; programmable; input resistance > 100 kΩ accepted prolonged input overload: 20%
Accuracy	0,1% @25°C ± one digit
Stability	50 ppm/°C
Outputs (option)	0, 1 or 2 x REL $I_{max}=1A$, $U_{max}=30VDC/250VAC$ ($\cos\phi=1$) or OC $I_{max}=30mA$, $U_{max}=30VDC$, $P_{max}=100mW$
Power supply output	24V DC +5%, -10% / max. 100 mA, stabilized
Communication interface	RS-485, 8N1 and 8N2, 1200 bit/s ÷ 115200 bit/s, Modbus RTU (not galvanically isolated)
Operating temp.	0°C ÷ +50°C (standard), -20°C ÷ +50°C (option)
Storage temp.	-10°C ÷ +70°C (standard), -20°C ÷ +70°C (depending on option)
Protection class	depending on display size: 5 x 9 mm display: IP 65 (front), available additional frame IP 65 for panel cut-out sealing; IP 20 (case and connection clips) 4 x 13 mm display: IP 40 (front); IP 20 (case and connection clips)
Case	panel mounting; material: NORYL - GFN2S E1
Dimensions	case (WxHxD): 72 x 36 x 97 mm panel cut-out dimensions: 66,5 x 32,5 mm installation depth: min. 102 mm board thickness: standard 7 mm or other depending on used board thickness brackets (see Accessories)
Weight	162 g max.

DIMENSIONS

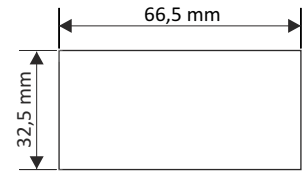
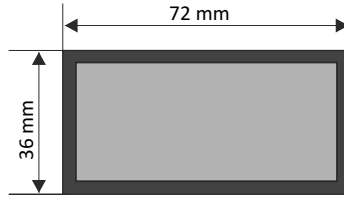
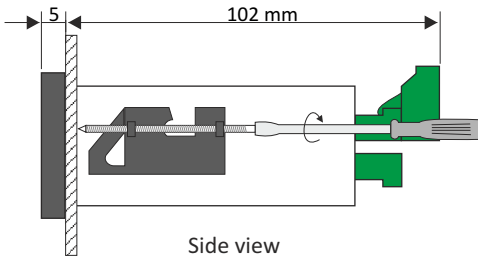

EXAMPLARY PIN ASSIGNMENTS

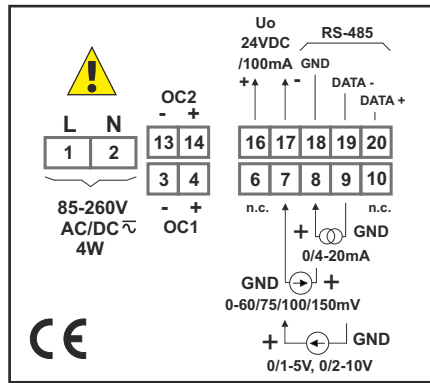
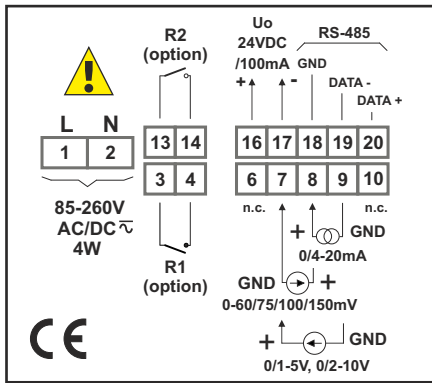

ORDERING

SRP-73-1XXX-1-X-XX1

type of input:

8 : 0-20 mA, 4-20 mA, 0/1-5V, 0/2-10V
 C : 0-60/75/100/150 mV

number of outputs:

0
 1
 2

type of outputs:

0 : no output
 1 : REL
 2 : OC

options:

00 : no options
 01 : IP 67 frame
 08 : operating temp. -20°C ÷ +50°C
 0P : IP 67 frame + operating temp. -20°C ÷ +50°C

power supply:

3 : 24V AC/DC
 4 : 85V - 260V AC/DC



MOUNTING PLATES

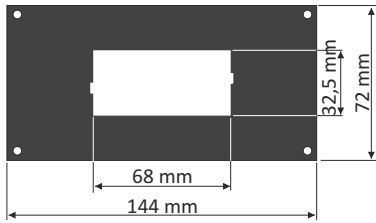

SMP-147/73
to mount 72 x 36 mm
size unit in place
of 144 x 72 mm cut-out

BOARD THICKNESS BRACKETS / ADAPTORS



SPH-07
1 ÷ 7 mm board thickness brackets (2 pcs)
standard included with device



SPH-05
1 ÷ 5 mm board thickness brackets (2 pcs)



SPH-45
1 ÷ 45 mm board thickness brackets (2 pcs)

SOFTWARE

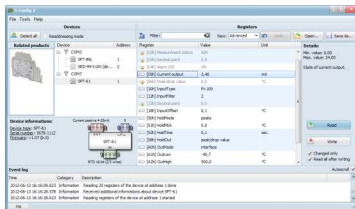

S-Config 2 is used for the simultaneous detection of devices in multiple Modbus RTU networks and allows user to change the configuration of most of them. For each detected device a list of its registers, which the user can modify, is displayed and also additional informations about device parameters (type, address in the network, etc.).

S-Config software can be downloaded from SIMEX website at www.simex.pl

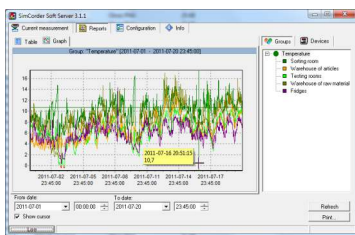

SimCorder Soft is a visualisation application created to facilitate work with advanced networks of the SIMEX devices, for acquisition, visualisation, reporting, archiving, exporting and printing of measurement data from all network devices. You can download measurements from the devices automatically or on demand. There is a possibility of immediate notification about emergency states via SMS or e-mail, which will often allow to quickly resolve an arising problem while avoiding long and expensive stoppages. You can view the measurement data, emergency states and configuration via the internet at every time.

CONVERTERS



The **SRS-U4** converter is designed to connect a USB host to slave devices equipped with RS-485 interface. The PC with special software can be used as a host. The **SRS-U4** unit guarantees full galvanic isolation between USB and RS-485 circuits. The converter can work with any devices equipped with RS-485 interface and contains integrated circuit which supports USB 1.1 and USB 2.0 standards. The main purpose is connection of PC host computer with industrial data acquisition and visualisation systems based on RS-485 interface.

The **SRS-U4** can be also manufactured with DIN mounting adaptor.