



IR remote controller  
SIR-15

## SWE-73-S

- ❑ low-cost meter in a small case
- ❑ no analog input
- ❑ RS-485 / Modbus RTU
- ❑ MASTER / SLAVE
- ❑ brightness adjustable in 8 steps
- ❑ all parameters are freely programmable with remote controller or free configuration software S-Config

The low-cost **SWE-73-S** is a simple digital panel indicator intended for displaying any numerical values and characters defined by user (in SLAVE mode only) sent from the master device over the RS-485 serial interface link. The displayed value may be collected from other device (in MASTER mode). The display brightness can be adjusted in 8 steps. The RS-485 interface makes it easy to set up measurement networks in production process monitoring systems, and also to use the indicators as smart, programmable, digital converters of input signals for computer systems. An additional advantage of the device is that its dimensions are small and it can be easily mounted. The meter can be configured with IR remote controller or free S-Config software via the RS-485 communication port. Configuration of the device can also be programmed to the customer's order.

### TECHNICAL DATA

Power supply Power consumption	110V AC $\pm$ 10% separated, 230V AC $\pm$ 10% separated or 24V DC (10V $\div$ 30V DC) not separated from measurement input; for 110V AC and 230V AC: max. 1,5 VA; for 24V DC: max. 1 W
Display	LED, red, 4 x 13 mm high, brightness adjustable in 8 steps
Displayed values range	-999 $\div$ 9999 + decimal point
Communication interface	RS-485, 8N1 and 8N2, 1200 bit/s $\div$ 115200 bit/s, Modbus RTU (not galvanically isolated)
Operating temp.	0°C $\div$ +50°C (standard), -20°C $\div$ +50°C (option)
Storage temp.	-10°C $\div$ +70°C (standard), -20°C $\div$ +70°C (depending on option)
Protection class	IP 65 (front), available additional frame IP 65 for panel cut-out sealing; IP 20 (case and connection clips)
Case	panel mounting; material: NORYL UL94V-0
Dimensions	<u>case (WxHxD)</u> : 72 x 36 x 77 mm (for 24V DC); 72 x 36 x 94 mm (for 110V AC and 230V AC) <u>panel cut-out dimensions</u> : 67 x 32,5 mm <u>installation depth</u> : min. 78 mm (for 24V DC); min. 95 mm (for 110V AC and 230V AC) <u>board thickness</u> : max. 5 mm
Weight	approx. 174 g



**DIMENSIONS**

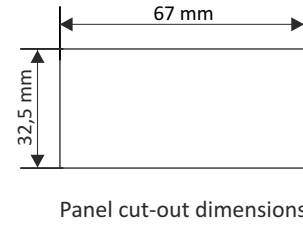
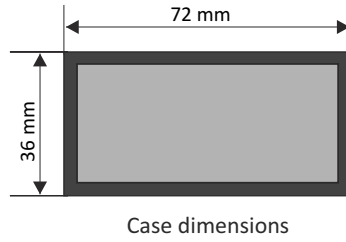
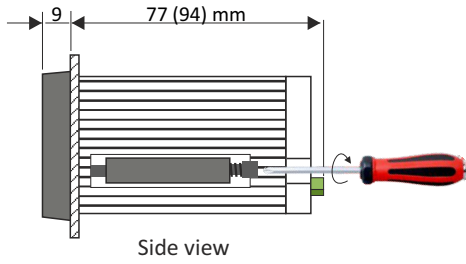

**PIN ASSIGNMENTS**

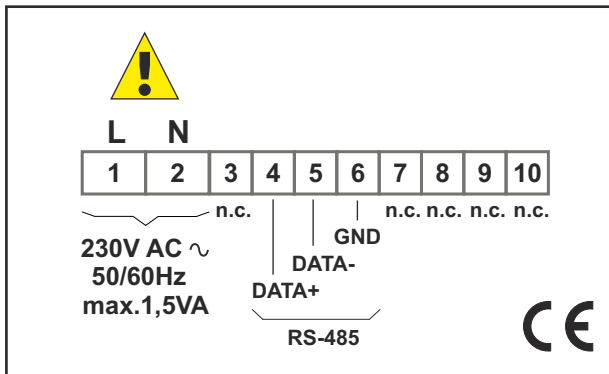

**ORDERING**

SWE-73-S-X-XX1-X

**power supply:**

- 1 : 24V DC (10 ÷ 30V DC)
- 2 : 230V AC
- 8 : 110V AC

**units:**

- 0 : no unit on display
- °C
- %
- bar
- m
- l/min
- A
- V
- MPa

**options:**

- 00 : no options
- 01 : IP 65 sealing gasket
- 08 : operating temp. -20°C ÷ +50°C
- 0P : IP 65 sealing gasket + operating temp. -20°C ÷ +50°C



## MOUNTING PLATES

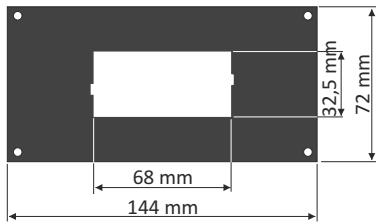

**SMP-147/73**  
to mount 72 x 36 mm  
size unit in place  
of 144 x 72 mm cut-out

## REMOTE CONTROLLER



### SIR-15

InfraRed remote controllers may be used as external programming keyboard for all SIMEX devices equipped with IR receivers and remote programming functions. Pressing of any local IR controller key, causes transmission of its code to the device. Functions of particular keys depend on devices features.

Power supply voltage: 6V DC - 4 alkaline batteries type LR44  
Operation range: from 0,5 to 5 m (depend on programmed device features)

## SOFTWARE

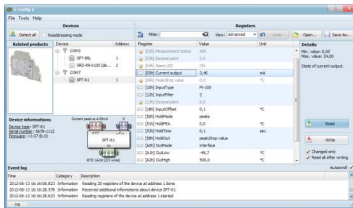

**S-Config 2** is used for the simultaneous detection of devices in multiple Modbus RTU networks and allows user to change the configuration of most of them. For each detected device a list of its registers, which the user can modify, is displayed and also additional informations about device parameters (type, address in the network, etc.).

**S-Config** software can be downloaded from SIMEX website at [www.simex.pl](http://www.simex.pl)

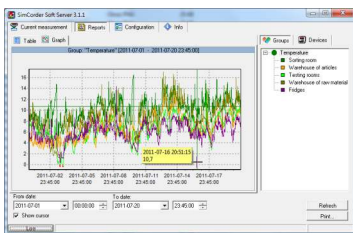

**SimCorder Soft** is a visualisation application created to facilitate work with advanced networks of the SIMEX devices, for acquisition, visualisation, reporting, archiving, exporting and printing of measurement data from all network devices. You can download measurements from the devices automatically or on demand. There is a possibility of immediate notification about emergency states via SMS or e-mail, which will often allow to quickly resolve an arising problem while avoiding long and expensive stoppages. You can view the measurement data, emergency states and configuration via the internet at every time.

## CONVERTERS



The **SRS-U4** module is designed to connect a USB host to slave devices equipped with RS-485 interface. The PC with special software can be used as a host. The **SRS-U4** unit guarantees full galvanic isolation between USB and RS-485 circuits. The converter can work with any devices equipped with RS-485 interface and contains integrated circuit which supports USB 1.1 and USB 2.0 standards. The main purpose is connection of PC host computer with industrial data acquisition and visualisation systems based on RS-485 interface.

The **SRS-U4** can be also manufactured with DIN mounting adaptor.

